

NOVEL
radio

Handheld transceiver VHF-UHF

EP-100 EP-400 ATEX 

User manual

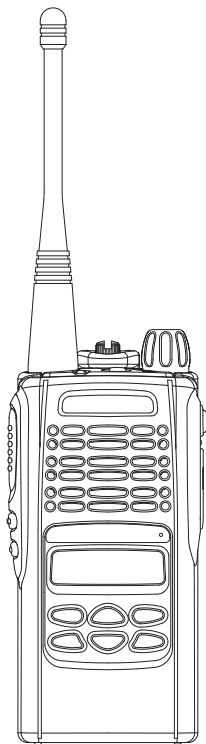

CONTENTS

1. Main Features	2	RX tone	16
2. Main Item	3	Talk around	16
3. Battery Installation	4	Scrambler	17
4. Antenna Installation	5	Alert ON/OFF	17
5. Radio Operation	6	Key lock	18
6. Panel Description	7	SQ level	18
7. LCD Indicators	9	Scan	19
8. Menu Navigation Chart	10	DTMF	19
9. Functions		VOX ON/OFF	20
Selecting a radio channel	11	VOX level	20
Missed call list	12	Whisper mode	21
Contact list	12	10. Battery Information	22
Lone worker	13	11. Charger Information	23
Status call	14	12. CTCSS/DCS TONE Frequency Chart	25
Group	15	13. Certification	27
TX tone	15	14. Declaration of Conformity	28
		15. Approval	29

1. Main Features

- 255 Programmable channel
- Durable body
- Clear and high quality sound
- Practical function and user friendly operation
- LCD displaying various information
- Widely usable frequency range
- IP54, MILSTD-810F approved
- Firmware update

2. Main Item

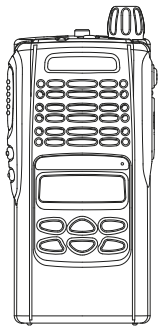

Radio

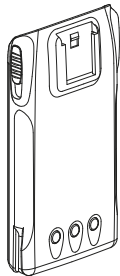

Li-ion Battery



Belt Clip



Antenna

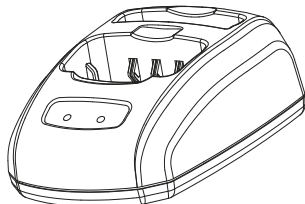

Charger



Hand Strap

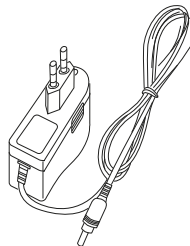

Adapter



User Manual

3. Battery Installation

These operations must be done only in a non-hazardous area

Attaching the Battery

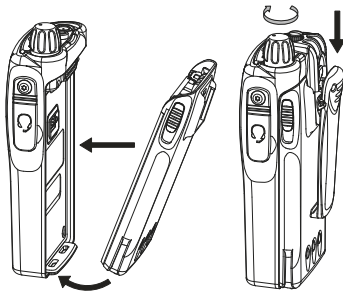

1. Turn off the radio, if it is turned on.
2. Fit the extensions at the bottom of the battery into the slots at the bottom of the radio's body.
3. Press the top part of the battery towards the radio until you hear a 'click's sound.
4. Fix the belt clip on the battery, turn the belt screw clockwise to fasten it while you push it down.

Removing the Battery

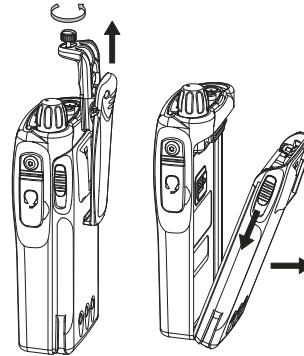

1. Turn off the radio, if it is turned on.
2. Turn the belt screw counterclockwise at the top of the battery until you can remove the belt clip from the battery.
3. Slide the battery latches on both sides of the battery downwards.
4. Pull the top part of the battery away from the radio's body and remove the battery.

4. Antenna Installation

Attaching the Antenna



1. Align the threaded end of the antenna with the radio's antenna connector.
2. Turn the antenna clockwise to fasten it.

Removing the Antenna

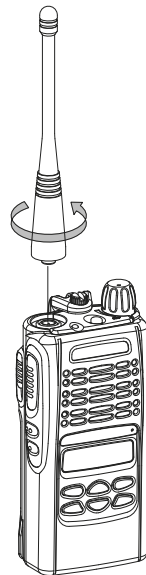

1. Turn the antenna counterclockwise until you can remove it.

5. Radio Operation

Turning the Radio ON or OFF

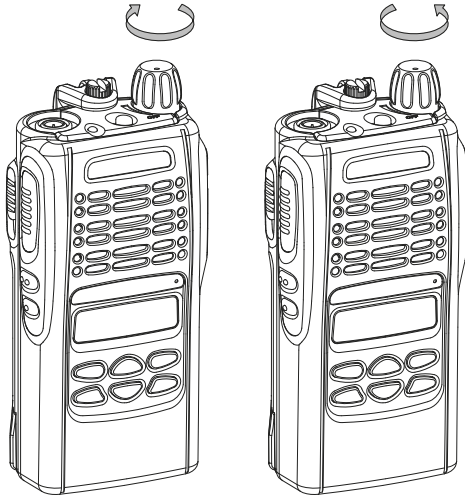

To turn the radio on, turn the ON-OFF/Volume control knob clockwise.

To turn the radio off, turn the ON-OFF/Volume control knob counterclockwise until you hear a click.

6. Panel Description

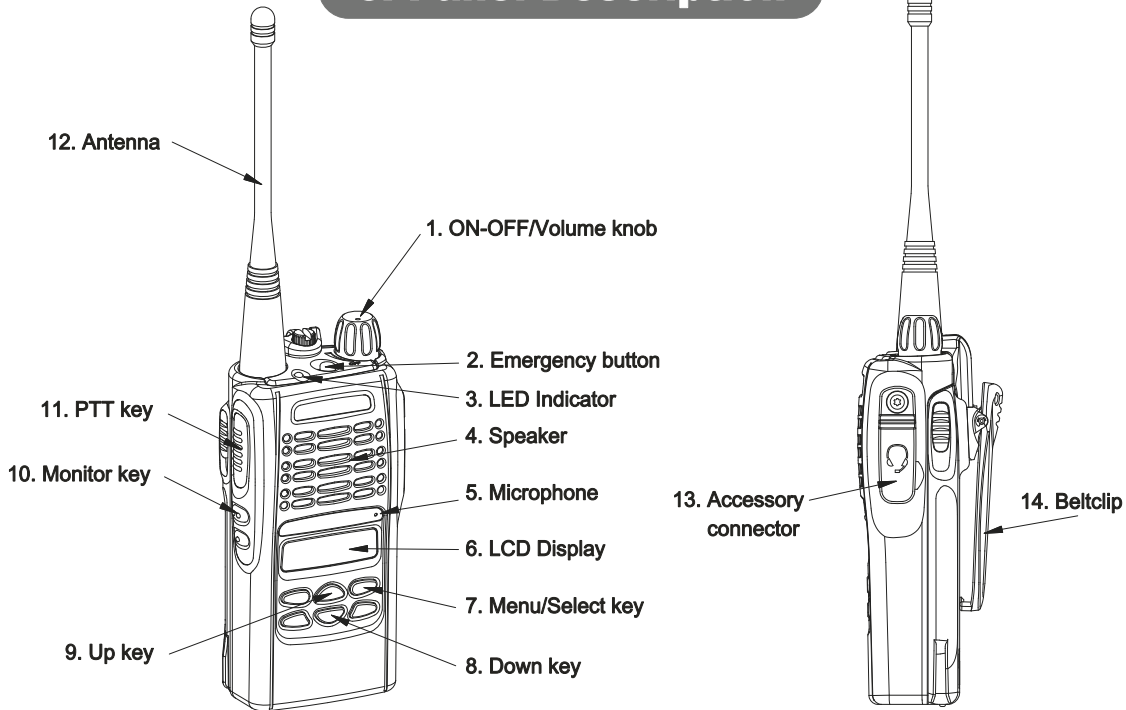

1. ON-OFF/Volume knob

Turn the power/volume control knob clockwise to turn the radio on.

2. Emergency button

The emergency function allows you to send an emergency signal quickly and easily to your base station, etc. in case of emergency.

3. LED Indicator**4. Speaker****5. Microphone****6. LCD****7. Menu/Select key**

This key is used to choose Menu selection, displays variety of information such as, Missed call list, Contact list, Lone worker etc.

8. Down key

Select the desired channel or scroll menu function

9. Up key

Select the channel or scroll menu function.

10. Monitor button

Press the Monitor key momentarily to disable the Tone squelch.

11. PTT key

Push and hold to transmit or release to receive signal.

12. Antenna**13. Accessory connector**

Connects headsets, remote speaker/microphones and other accessories. Replace attached dust cap when not in use.





14. Beltclip





All of your radio buttons can be programmed by programming software to activate the radio fetures.

7. LCD Indicators



Channel:255

Indicator	Description
	Indicate relative signal strength level.
	Key Lock Indicator. Appears during key lock function on.
	Alert(Beep) ON/OFF Indicator. Appears when beep sound is turned on.
	Battery Level Indicator. Indicates remaining battery power.
	VOX Indicator. Appears when VOX function is turned on.

Indicator	Description
	Scan Indicator. Appears when scan function is activated.
	Scrambler Indicator. Appears while the voice scrambler function is activated.
	Talk Around Indicator.
	Tone Indicator. Appears when the frequency is set with Tone.
	Monitor Indicator. Appears when press the Monitor key.

8. Menu Navigation Chart

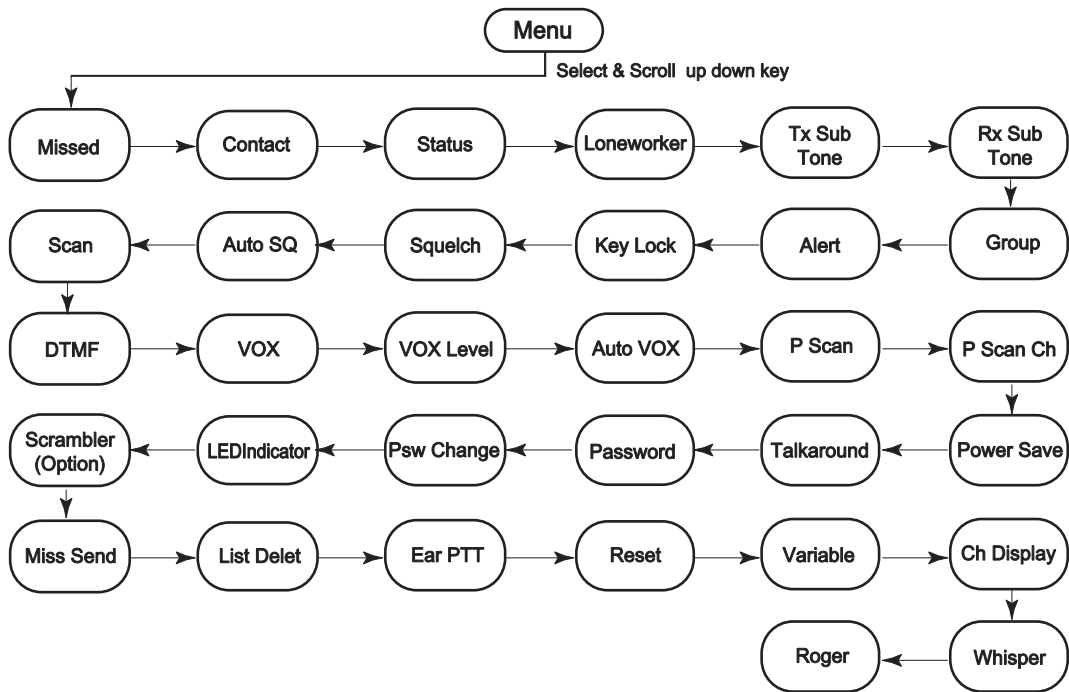

9. Functions

Selecting a radio channel

This radio offers up to 255 channels.



Select the desired channel by using Up/Down key.
Each press increases/decrease the channel number.
When held down, the channels increase continuously.

Select the desired channel by using Down key. Each
press decreases the channel number.
When held down, the channels decrease continuously.

Transmission signal

To transmit, monitor the channel and make sure it is clear. **THIS IS AN FCC REQUIREMENT!**

To transmit, press and hold in the PTT switch.
Speak into the microphone area of the panel grill in a normal voice level. To return to the Receive mode, release the PTT switch.

Missed call list

If a call remains unanswered, the call will be stored by the radio, provided that Missed calls has been programmed into your radio.

Up to 16 calls can be stored. If the same radio calls more than once, only the most recent call is stored. When fifteen calls have been stored by the radio, depending on the radio programming the sixteenth call received may overwrite the first or not be stored by the radio.



If the displays shows S there is a status message associated with the call.

Method

1. to enter Menu mode.
2. to select.
3. to scroll list.

Contact list

During a call, the contact list may be used to give access to up to 16 preprogrammed numbers accessed via the menu.



Method

1. to enter Menu mode.
2. to scroll list.
3. to select.







Lone worker

The Lone worker function enables you to work alone with more safety.

You can switch ON and OFF Lone worker by using a pre-programmed Lone worker button or through the menu.



Method





1.  to enter Menu mode.
2.   to scroll list until Lone worker.
3.  to select.
4.  or  to turn ON/OFF.
5.  to select.

Status call

A status is a code for transmitting prearranged messages, e.g. status "03" may indicate "launch". The prearranged messages and associated code digits are contained in a Status list which contains up to 30 entries.









Method

1.  to enter Menu mode.
2.   to scroll list until Status.
3.  to select.

Making a status call

Method

1.  to enter Menu mode.
2.   to scroll list until Status.
3.  to select.
4.  or  to select Status list.
5. Press the PTT button.

Group



Method

1. to enter Menu mode.
2. to scroll list until Group.
3. to select.
4. or to scroll list.
5. to select.

TX tone

This function is used to change TX tone such as CTCSS, DCS.



Method

1. to enter Menu mode.
2. to scroll list until TX tone.
3. to select.
4. or to select whether CTCSS or DCS.
5. to select.

There are 59 CTCSS code (1~59)

Refer to CTCSS frequency chart p.25 and No.57~59 are programmable.

There are 104 DCS code(101~204)

0 means no Tone

RX tone

This function is used to change RX tone such as CTCSS, DCS.



Method

1. to enter Menu mode.
2. to scroll list until RX tone.
3. to select.
4. or to select whether CTCSS or DCS.
5. to select.

There are 59 CTCSS code (1~59)

Refer to CTCSS frequency chart p.25 and No.57~59 are programmable.

There are 104 DCS code(101~204)

0 means no Tone

Talk around

To talk directly with another radio without going through a system or dispatcher.



Method

1. to enter Menu mode.
2. to scroll list until Talk around.
3. to select.
4. or to turn ON/OFF.
5. to select.

Scrambler

This function provides higher communication security.



Method

1. to enter Menu mode.
2. to scroll list until Scrambler.
3. to select.
4. or to turn ON/OFF.
5. to select.

Alert ON/OFF

Alert ON/OFF indicator appears when Alert sound is turned ON.



Method

1. to enter Menu mode.
2. to scroll list until Alert.
3. to select.
4. or to turn ON/OFF.
5. to select.

Key lock

Key lock indicator appears during key lock function is ON.



Method

1. to enter Menu mode.
2. to scroll list until Key lock.
3. to select.
4. or to select lock/unlock key.
5. to select.

SQ level

SQ level function is to adjust the squelch sensitivity. Initial level is set to level 4.



Method

1. to enter Menu mode.
2. to scroll list until Squelch.
3. to select.
4. or to adjust the desired Squelch level.
5. to select.

Scan

Scan indicator appears when scan function is activated.



Method

1. to enter Menu mode.
2. to scroll list until Scan.
3. to select for scanning.
4. or to turn ON/OFF.
5. to select.

DTMF

This function allows you to distinguish the radios of other systems and make an individual call.



Method

1. to enter Menu mode.
2. to scroll list until DTMF.
3. to select.
4. or to turn ON/OFF.
5. to select.

VOX ON/OFF

VOX ON/OFF indicator appears when beep sound is turned ON.



Method

1. to enter Menu mode.
2. to scroll list until VOX ON/OFF.
3. to select.
4. or to turn ON/OFF.
5. to select.

VOX level

This function is to adjust the VOX level.
The initial level is set to Level 8.



Method

1. to enter Menu mode.
2. to scroll list until VOX level.
3. to select.
4. or to adjust the desired VOX level.
5. to select.

Whisper mode



High : High sensitivity Low : Normal sensitivity



Method

1. to enter Menu mode.
2. to scroll list until Whisper.
3. to select.
4. or to move to the desired Mic.
sensitivity (High/Low).
5. to select.

10. Battery Information

- The Li-ion battery for EP Series  is very reliable and safe.
- To keep the optimum capacity and for safe operation, please fully charge the battery before use.
- The battery is designed for the EP Series  charger only. Please do not charge the battery with other brand's charger.
- In case the battery is attached to the radio(EP Series ), please turn the radio off before charging it in order for full charge.
- Please do not disassemble or make it short circuit.
- If the battery terminal is contacted with any metals or conductive substances, it may harm to a human body or goods. Please be careful not to contact.
- Battery life(5:5:90 duty cycle) : more than 10 hours

11. Charger Information

Specification

- Input voltage: DC 12V 1A
- Output voltage: DC 8.4V 850mA
- Charge time: Two and half hours

Operating instruction

- Plug the AC power cord of the charger into a wall outlet.
- Turn the transceiver off.
- Insert the battery pack into the charger with or without the transceiver attached.

COLOR	OPERATING STATUS
RED ON	Under Charging
GREEN ON	Charging Completion
YELLOW ON	Standby
YELLOW FLICKERING	Abnormal Temperature
RED FLICKERING	Abnormal Battery

PRECAUTION

- This charger should be used with EP series  battery pack only.
- Do not use this charger as a power supply.
- Do not use other power supply except for DC 12V 1A .
- Do not insert the transceiver while it is switched on.
- Pull out the plug when the charger is not in use.
- Operating temperature: 0°C ~ 40°C.
- Keep the charger out of the direct rays of the sun and humidity.
- Do not make the charger contact with any metals or any conductive substances.
- In case the charger gets wet, do not switch on and contact with your dealer immediately.

12. CTCSS/DCS TONE Frequency Chart

CTCSS Frequency Chart

NO	Freq (Hz)	NO	Freq (Hz)	NO	Freq (Hz)	NO	Freq (Hz)
001	67.0	015	110.9	029	179.9	043	196.6
002	71.9	016	114.8	030	186.2	044	199.5
003	74.4	017	118.8	031	192.8	045	206.5
004	77.0	018	123.0	032	203.5	046	229.1
005	79.7	019	127.3	033	210.7	047	254.1
006	82.5	020	131.8	034	218.1	048	71.0
007	85.4	021	136.5	035	225.7	049	165.5
008	88.5	022	141.3	036	233.6	050	171.3
009	91.5	023	146.2	037	241.8	051	177.3
010	94.8	024	151.4	038	250.3	052	198.0
011	97.4	025	156.7	039	069.3	053	202.7
012	100.0	026	162.2	040	159.8	054	60.7
013	103.5	027	167.9	041	183.5	055	62.5
014	107.2	028	173.8	042	189.9	056	64.7

DCS Code Chart

NO	Code	NO	Code	NO	Code	NO	Code	NO	Code	NO	Code
101	023	119	131	137	261	155	431	173	654	191	252
102	025	120	132	138	263	156	432	174	662	192	255
103	026	121	134	139	265	157	445	175	664	193	266
104	031	122	143	140	271	158	464	176	703	194	274
105	032	123	152	141	306	159	465	177	712	195	325
106	043	124	155	142	311	160	466	178	723	196	332
107	047	125	156	143	315	161	503	179	731	197	356
108	051	126	162	144	331	162	506	180	732	198	446
109	054	127	165	145	343	163	516	181	734	199	452
110	065	128	172	146	346	164	532	182	743	200	454
111	071	129	174	147	351	165	546	183	754	201	455
112	072	130	205	148	364	166	565	184	053	202	462
113	073	131	223	149	365	167	606	185	122	203	523
114	074	132	226	150	371	168	612	186	036	204	526
115	114	133	243	151	411	169	624	187	145		
116	115	134	244	152	412	170	627	188	212		
117	116	135	245	153	413	171	631	189	225		
118	125	136	251	154	423	172	632	190	246		

CERTIFICATION

Certification

ATEX approved
Intrinsically Safe
IECEX TRC 10.0009X
Ex ib IIC T4 Gb
TRAC10ATEX21266X



ATEX MARKING	
II	Surface industries (no mining)
2	High protection
G	Gas explosive atmosphere
Ex	European Directive ATEX and IECEx
ib	Intrinsically safe protection
IIC	Environment with explosive gas (including hydrogen)
T4	Temperature class (max 135°C)
Gb	Device with high level protection

SAFETY NOTES

- EP-Series  radios must always be used within the terms of their certification.
- Keep the radios away from aggressive substances. If used in a hostile environment, extra protection may be needed.
- To prevent ignition of hazardous atmospheres, batteries must only be charged, attached or removed in an area known to be non-hazardous.
- Use of battery chargers other than the charger supplied will invalidate the explosion protection certification.

Declaration of Conformity

We, E-TECH CO., LTD.

Hereby declare that the products

Model: EP100 Type : FM Handheld Transceiver (VHF)

Model: EP400 Type : FM Handheld Transceiver (UHF)

satisfy all the technical regulations applicable to the product within the scope of Council

Directives 73/23/EEC, 89/336/EEC and 99/5/EC:

Radio : EN 300 086-2 V1.1.1

EMC : EN 301 489-1 V1.6.1, EN 301 489-5 V1.3.1

Safety : EN 60950-1:2001+A11:2004

All essential radio test suites have been carried out.

This declaration is issued under the sole responsibility of the manufacturer and, if applicable, his authorized representative.

NOTIFIED BODY: EMCert Dr. Rasek
Boelwiese 5 91320 Ebermannstadt Germany

MANUFACTURER or AUTHORISED REPRESENTATIVE:
E-TECH CO., LTD.
#403-901, Techno Park Complex, 193, Yakdae-dong,
Wonmi-gu, Bucheon-city, Kyunggi-do, 420-734, Korea

POINT OF CONTACT: E-TECH CO., LTD.

TEL:82-32-328-3184 / FAX:82-32-328-3186
Kyunggi-do, Korea / Jan 31. 2008

(Place, date of issue)

E-TECH Co., Ltd.

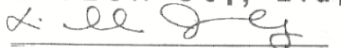

President / I. J. KIM

(Signature)

APPROVAL

1. FCC APPROVAL

Safety Training Information

Your FM Handheld Transceiver generates RF electromagnetic energy during transmit mode.

This radio is designed for and classified as "Controlled Exposure / Occupation Environment", meaning it must be used only during the course of employment by individuals aware of the hazards, and the ways to minimize such hazards.

This radio is NOT intended for use by the "General Population / Uncontrolled Environment.

This radio complies with FCC RF radiation exposure limits set forth for a controlled environment.

This radio should be installed and operated with a minimum distance of 2.5 centimeters between the radio and your body. Therefore, to ensure that your exposure to RF electromagnetic energy is within the FCC allowable limits for occupational use, always follow below information.

Do not operate the radio without a proper antenna as this may damage the radio and may also cause you to exceed FCC RF exposure limits. A proper antenna is the antenna supplied with this radio by the manufacturer for use with this radio.

Do not transmit for more than 50% of total radio use time("50% duty cycle"). Transmitting more than 50% of the time can cause FCC RF exposure compliance requirements to be exceeded.

Always use supplied accessories (antenna,batteries, belt clips, speaker/mic etc.)

Use of unauthorized accessories can cause the FCC RF exposure compliance requirements to be exceeded.

Always keep the antenna at least 2.5 cm (1 inch) away from the body when transmitting and only use the belt-clips, when attaching the radio to your belt, etc., to ensure FCC RF exposure compliance requirements are not exceeded.

FCC ID

EP100 : R72EP100

EP400 : R72EP400

2. CE APPROVAL

The E-Tech transceiver meets the following essential requirement.

EP60, EP100, EP400

EP60950-1/+A11

EP301489-1-5

EP300086-2

CE0678 ⓘ



Novelradio Srl - Via Elba, 12 - 20144 Milano

Tel. +39.02.433817 / 02.4981022 - Fax +39.02.4987829

WWW.NOVELRADIO.IT - E-mail info@novelradio.it